

Dishwasher

Use & Care Manual

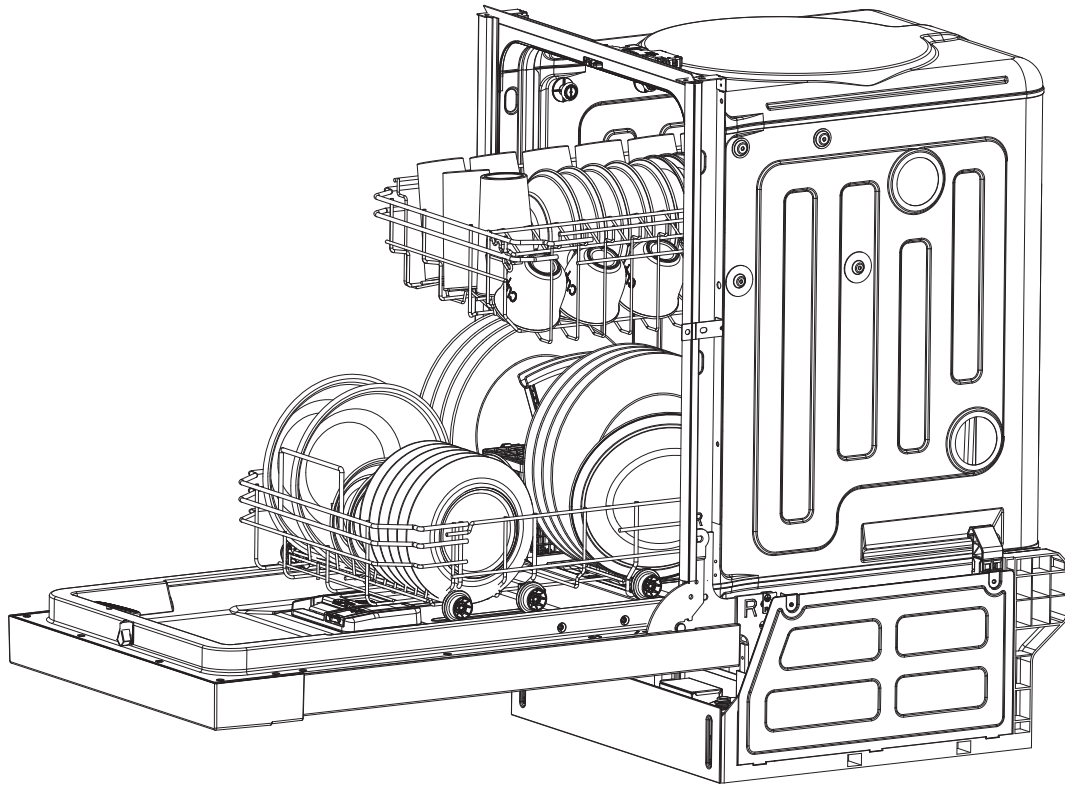

18 inch Built-In Dishwasher



ENB6631PEBS
ENB6631PEBW
ENB6631PEBB

Table of Contents

Important Safety Instructions	1
Features of Your New Dishwasher	2-4
Operating Instructions	5-7
Preparing and Loading Dishes	8-12
User Maintenance	13-14
Troubleshooting	15-17

IMPORTANT SAFETY INSTRUCTION

WARNING

For your safety, please follow the information in this manual to minimize the risk of fire, explosion, electric shock, and to help prevent property damage or personal injury.

Proper installation

Please install your dishwasher properly, follow the installation guide.

- Water supply inlet temperature should be between 120°F and 149°F.
- Dispose of the discarded appliance and packing material properly.
- The dishwasher must be properly grounded, or it can result in a risk of electric shock. PERMANENTLY CONNECTED is allowed.
- If there is any damage to the dishwasher, please contact to your dealer and do not attempt to repair or replace any part by yourself.

Basic precaution before use

- Read all instructions before using the dishwasher.
- The manual does not cover every possible condition and situation that may occur.
- Use the dishwasher only for intended function as described in this manual.
- When loading items to be washed:
 - Load sharp items and knives so that they are not likely to damage the door seal and tub.
 - Load sharp items and knives with the handles up to reduce the risk of injury.
- Do not wash plastic items unless they are marked dishwasher safe, if not marked, check with manufacture for recommendation, items that are not dishwasher safe may melt and create a potential fire hazard.
- If the dishwasher drains into a garbage disposal, make sure disposal is completely empty before running dishwasher.
- Do not tamper with controls.
- Do not operate your dishwasher unless all enclosure panels are in the proper place.
- Do not touch the heating element during or immediately after use, especially if the sanitize option has been selected.
- To reduce the risk of injury, do not allow children to play in or on a dishwasher.
- Do not let children abuse, sit, or stand on door or racks of the dishwasher.
- Under certain conditions, hydrogen gas may be produced in a hot water system that has not been used for two weeks or more. HYDROGN GAS IS EXPLOSIVE. If the hot water system has not been used for such a period, before using dishwasher, turn on all hot water faucets and let water flow from each for several minutes. This will release any accumulated hydrogen gas. Hydrogen gas is flammable. Do not smoke or use an open flame during this time.
- Do not store or use combustible materials, gasoline or other flammable vapors and liquids in the vicinity of this or any other appliance.
- Use only detergents or rinse agents recommended for use in a dishwasher and keep them out of the reach of children.
- Keep young children and infants away from dishwasher when it is operating.
- Do not use the dishwasher if it has a damaged power line or plug, and do not plug the dishwasher into a damaged outlet. Failure to observe these instructions may result in electrical shock.
- Remove the door to the washing compartment when removing an old dishwasher from service or discarding it.

FEATURES OF YOUR NEW DISHWASHER

Specification

Capacity	8 place settings
Dimension	17.6 x 22.6 x 32.4 inches (W x D x H)
Power Supply	120volts, 60Hz
Rated Power Usage	Wash motor 100W Heater 700W
Water Feed Pressure	5.8 ~ 145 psi (0.04 ~ 1MPa)

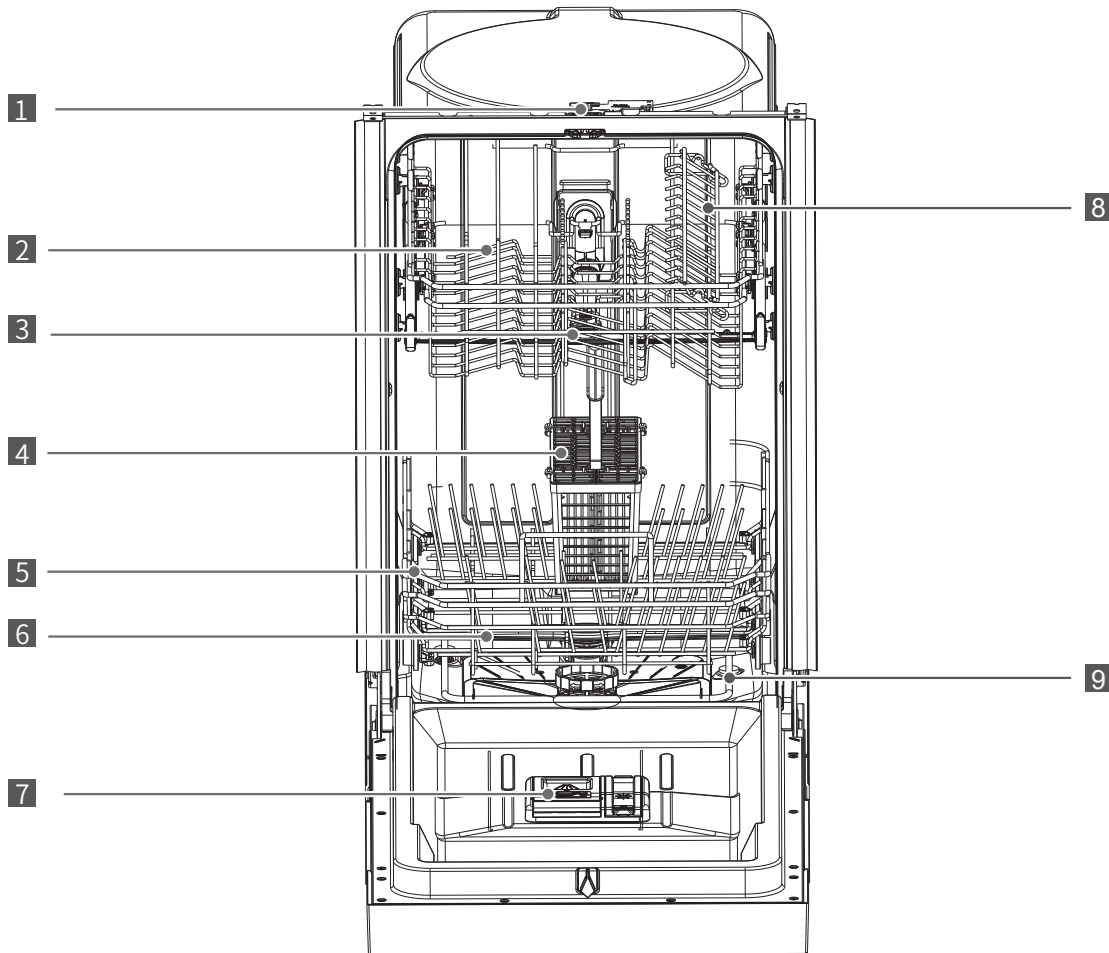

- 1** Lock
- 2** Upper Basket
- 3** Upper Spray Arm
- 4** Cutlery Basket
- 5** Lower Basket
- 6** Lower Spray Arm
- 7** Rinse Aid Dispenser
- 8** Cup Shelf
- 9** Heating Element

FEATURES OF YOUR NEW DISHWASHER

Features

Filter System

Your dishwasher has a multiple filter system. In the system there are three mesh filters. It can separate soiled water and clean water in different chambers.

The multiple filter system helps your dishwasher to get better performance with less water and less energy.

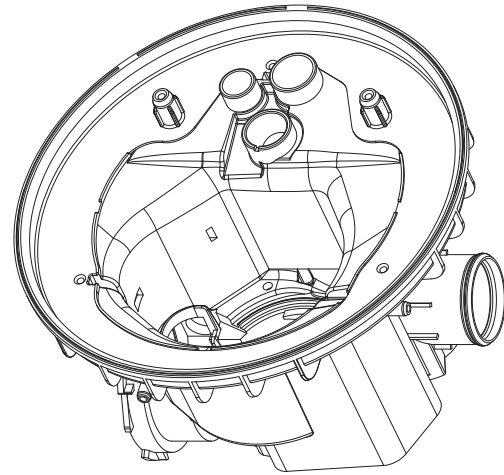

Smart Wash System

Your dishwasher has a Smart Wash System. When a partial load of lightly soiled dishes is placed in the unit, a wash cycle similar to a short wash will automatically be performed. When a full load of heavily soiled dishes is placed in the unit, a heavy wash cycle will automatically be performed. It can determine the type of cycle required to clean the dishes and will clean more efficiently every time.

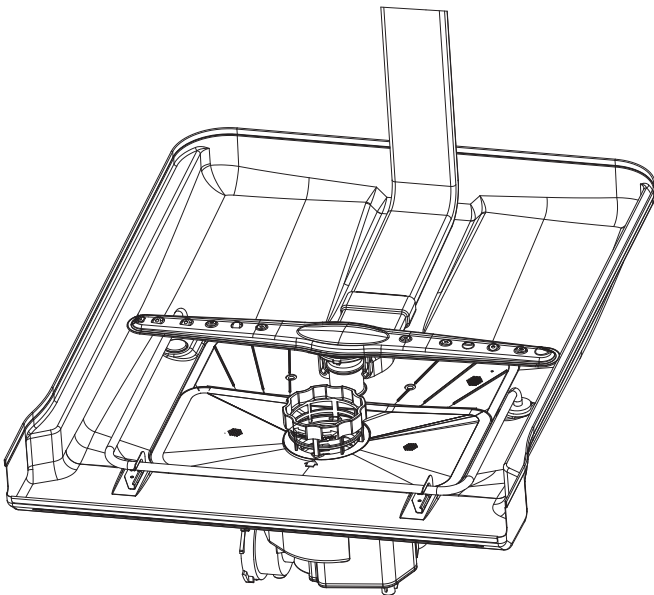
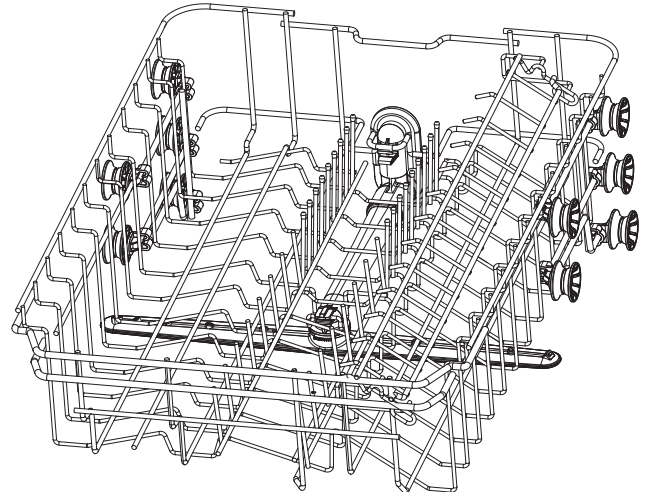

FEATURES OF YOUR NEW DISHWASHER

How Your Dishwasher Cleans

Your dishwasher cleans by spraying a mixture of hot water and detergent through the spray arms against soiled surfaces .

The dishwasher fills with water covering the filter area. Water is then pumped through the multiple filter and spray arms. Separated soil particles go down the drain as the water is pumped out and replaced with clean water.

The number of water fills will vary with the cycle being used.

Getting Started

1. Load the dishwasher (See Dish Preparation and Loading sections).
2. Add detergent (See Filling the detergent dispenser).
3. Add rinse aid (See Filling the rinse aid dispenser).
4. Close door.
5. Select desired CYCLE (See Cycle Chart).
6. Select desired OPTIONS (See Control Panel).
The indicator light above the pad will glow when selected.
7. Run the hot water faucet nearest the dishwasher until the water is hot, then turn it off.
8. To start, press Start/Cancel (See Control Panel).

Note:

Your dishwasher has the controls mounted in the front of the door. The door should be closed first if you want to operate the machine.

Wash Cycle Selections

Cycle times are approximate and will vary with the options selected. Hot water is necessary to activate the detergent and melt fatty food soils. An automatic sensor will check the incoming water temperature. If it is not at the appropriate temperature the timer will delay the cycle to allow automatic water heating during the main wash. When the HI-TEMP wash is selected an even higher temperature will be assured to handle heavier soil loads.

OPERATING INSTRUCTIONS

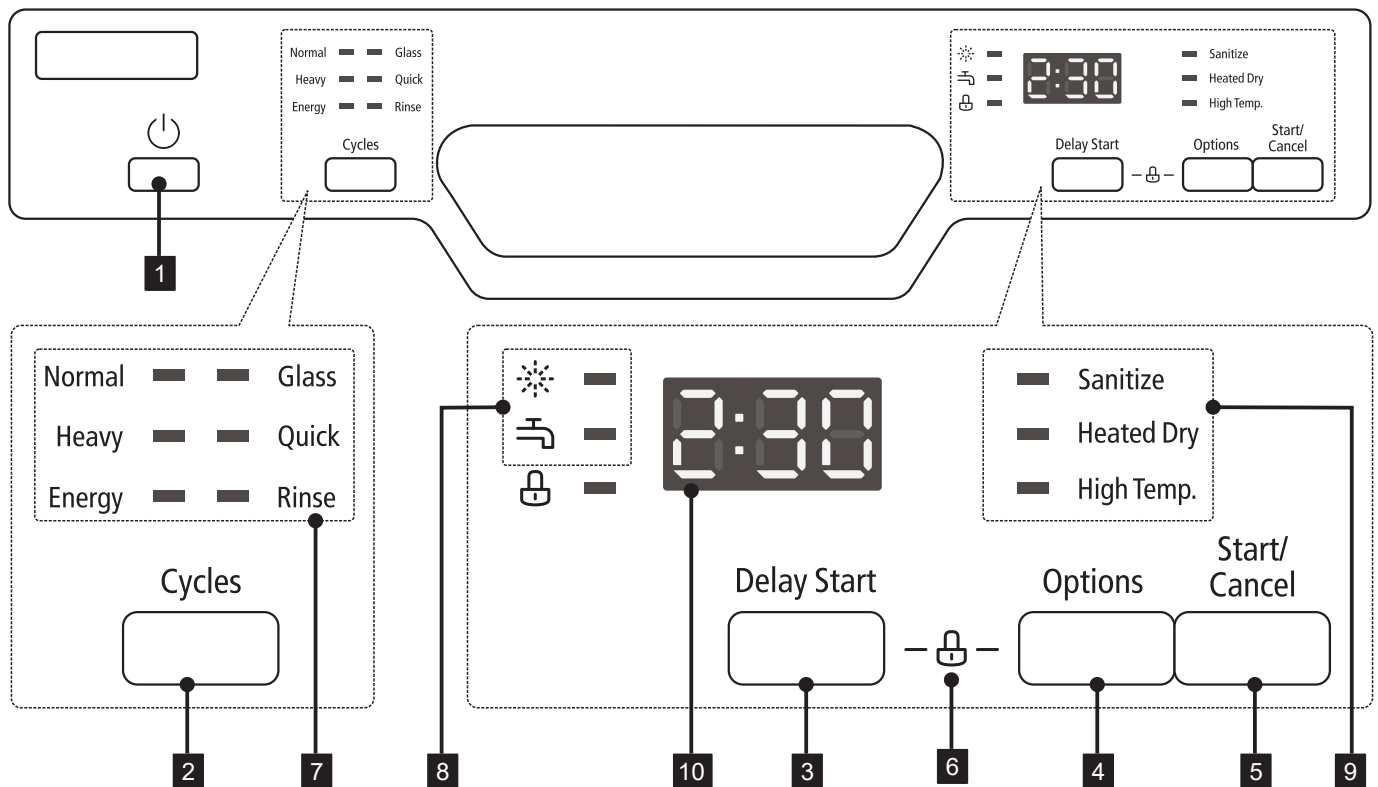

1. Power button

Switch on / off the power by pushing

2. Cycles button

To select the program by pushing.

3. Delay Start button

To set the delay start time, showing in the display window as H01-H24.

4. Options button

To select the function after setting the program.

5. Start/Cancel button

Start the washing program or cancel the washing program when the machine is working.

6. Child lock

When the appliance is running, push both "Delay Start" and "Options" button 3s to lock all buttons, as the same method to cancel locked state.

7. Wash Cycle Selections

■ Normal

This is standard program, this cycle is for regularly soiled dinner dishes or silverware.

■ Heavy

This cycle is for hard-to-clean, heavily soiled dishes, pots, pans, and dishes.

■ Energy

It is suitable to clean normally soiled tableware and it is the most efficient program in terms of its combined energy and water consumption for that type of tableware.

■ Glass

For lightly soiled loads, such as glasses, crystal and fine china.

■ Quick

A shorter wash for lightly soiled loads that do not need drying.

■ Rinse

Use for rinsing dishes glasses and silverware that will not be wash right away.

OPERATING INSTRUCTIONS

8.Warning indications

Rinse detergent deficient

When the indication lights on, please refill the detergent from the hole located on the dispenser.

Faucet warning

When the indication lights on, you should open the water tap, no water flow into the sump.

9.Options

Sanitize

When the "Sanitize" function is selected, the temperature of water will be maintained at 156.2°F (69°C) max. The max temperature may not be reached if the incoming water temperature is not correct. Certified residential dishwashers are not intended for licensed food establishments.

WARNING: The sanitize option is available with "Normal" "Heavy" and "Energy" cycles.

Heated Dry

When the "Heated Dry" function is selected, the heater will work during the drying process.

Hi Temp

When the "Hi Temp" function is selected, the temperature of the water will be maintained at 140°F (60°C) max.

10.Display window

This displays the remaining hours and minutes of the running cycle, delay hours and error codes etc.

OPERATING THE DISHWASHER

Status Window

H:01- H:24

If the Delay Start option is selected, the number of delay start hours shows in the status window.

2:25-0 :00

After the machine starts operation, the remaining time of the selected cycle will be shown in the window.

Error Indication

In certain situations, which are critical to the machines function and safe operation, the control will shut down and indicate an errorcode (See Error Codes on page 18).

If Error codes are displayed, contact the dealer or a serviceman. They will be able to provide assistance in troubleshooting the problem and or locate authorized service technician if needed.

NOTE

The remaining time could suddenly increase or drop several minutes. This means the Smart Sensor has checked the soil level and determined if additional water fills are needed or if water fills can be deleted.

Cycle Chart

Program	Description of Cycle	Water (L/G)	Cycle time (min)
Heavy	Pre Wash	19. 7L/5. 2G	155
	Main Wash(140°F)		
	Rinse(149°F)		
	Rinse(with Sani 156.2°F)		
	Drying		
NORMAL	Pre Wash	9.5~18.5L/ 2.5~4.9G	105~135
	Main Wash(122-131°F)		
	Rinse(136.4-140°F)		
	Rinse(with Sani156.2°F)		
	Drying		
Energy	Pre Wash	15. 5L/4.1G	105
	Main Wash(113-122°F)		
	Rinse(122-131°F)		
	Rinse(with Sani 156.2°F)		
	Drying		
Glass	Pre Wash	15.5L/4.1G	95
	Main Wash(118.4-122°F)		
	Rinse(122-131°F)		
	Drying		
Quick	Pre Wash	12.5L/3.3G	60
	Main Wash(122°F)		
	Rinse(131°F)		
Rinse	Pre Wash	6.7L/1.8G	20
	Main Wash		

PREPARING AND LOADING DISHES

Dish Preparation

Scrape away large pieces of food, bones, pits, toothpicks, etc. The continuously filtered wash system will remove the remaining food particles. Burned-on food should be loosened before loading. Empty liquids from glasses and cups. Food such as mustard, mayonnaise, vinegar, lemon juice and tomato based products may cause discoloration of stainless steel and plastics if allowed to sit for a long period of time. Unless the dishwasher is to be operated at once it is best to rinse off these food soils. If the dishwasher drains into a food disposal, be sure the disposal is completely empty before starting dishwasher.

Loading the Upper Basket

The upper basket is designed for cups, glasses, small plates, bowls and plastic items marked dishwasher safe etc.

For best results, place the bowls, cups, glasses, sauce pans with soiled surface facing down or toward the center. Tilt slightly for better drainage.

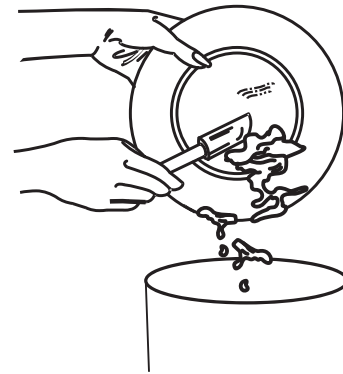

Loading the Bottom Basket

The bottom basket is designed to load plates, soup bowls, plates, saucers and cookware. The adjustable basket space will allow you to load items with a maximum height of 11 inches.

The fold-down tines in the bottom basket make it easy to load those extra large and hard-to-fit items. The tines may be left up for normal use or folded down for more flexible loading. Fold down for more space to load large pots or pans.



Make sure the loaded dishes do not interfere with the rotation of the middle spray arm, which is located at the bottom of the upper basket. (Check this by rotating the middle spray arm by hand.)



Large items should be placed along the edge so they do not interfere with the middle spray arm rotation, and make sure they not prevent the detergent dispenser from opening. Large items should be turned so that the inside faces downward, and make sure these items do not interfere with the lower spray arm rotation.

PREPARING AND LOADING DISHES

Loading the Lower Basket

The lower basket has been especially designed for dinner dishes, soup bowls, plates, pots, lids, and casserole dishes.

Load large items such as pans and pots into the dishwasher so their open sides face downwards. We recommend loading cups, stemware, and small plates into the upper basket.

See the recommended loading patterns below.

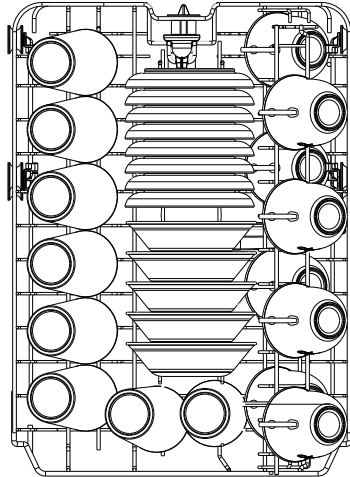

8 place setting

Loading the Upper Basket

The upper basket has been designed for small plates, mugs, glasses, and plastic items marked “dishwasher safe”. Load your plates into the dishwasher in two half rows, so that the front of each plate faces the back of the plate in front of it, and the open sides of the plates at the center of the dishwasher face each other. See the illustrations below.

Make sure the loaded dishes do not interfere with the rotation of the nozzle which is located at the bottom of the upper basket. (Check this by rotating the nozzle by hand.)

When loading dishes, pull the upper basket out sufficiently so you can load it without striking the counter

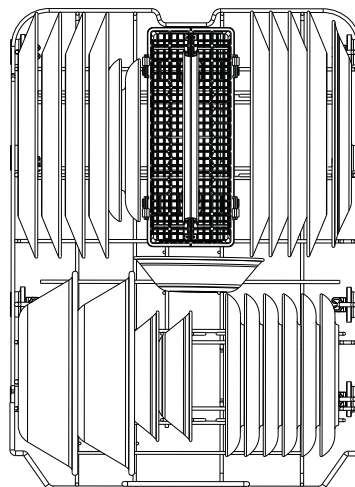

8 place setting

PREPARING AND LOADING DISHES

Loading the Silverware Basket

The silverware basket can be divided into three separate modules that can be used in both upper and lower racks.

1. Spoons
2. Knives
3. Salad forks
4. Forks
5. Large spoons
6. Large forks

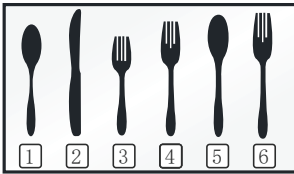
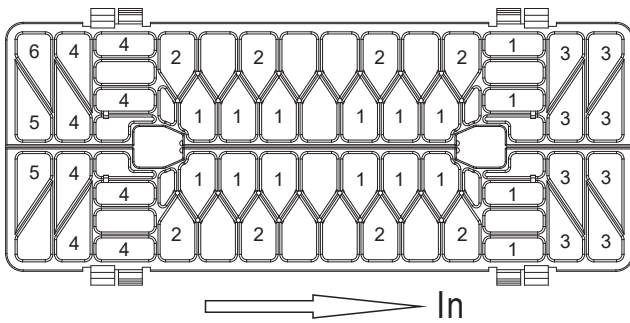

Adding A Dish

To add or remove items after wash cycle starts:

1. Open door slightly and wait a few seconds until wash action stops before completely opening.
2. Add the item.
3. Close the door firmly to latch within 4 secs, then cycle will automatically resume.



CAUTION

TO AVOID BURN INJURY: Slightly open door and wait until spray arms and wash action stop. Hot water may splash out of dishwasher. Failure to do so may result in injury.

Filling the Rinse Aid Dispenser

Rinse aid greatly improves drying and reduces water spots and filming. Without rinse aid your dishes and dishwasher interior will have excessive moisture.

The Heated Dry option will not perform as well without rinse aid. The rinse aid dispenser, located next to the detergent cup, automatically releases a measured amount of rinse aid during the last rinse.

If the rinse aid is low, the Rinse Aid light is illuminated at the beginning and end of the cycle indicating that it is time to refill.

WARNING

1. Do not let item extend through bottom.
2. Be sure nothing protrudes through bottom of the basket or rack to block the lower spray arm.

PREPARING AND LOADING DISHES

Filling the Rinse Aid Dispenser



Your dishwasher is designed to use a liquid rinse aid. The use of rinse greatly improves drying performance after the final rinse. Do not use a solid or bar-type rinse aid. Under normal conditions, the rinse aid will last approximately one month. It is best to keep it full, but do not over fill.

Filling the detergent dispenser

1. Open the detergent dispenser cap by pushing the detergent dispenser release catch.



The flap is always open at the end of a dishwashing cycle.

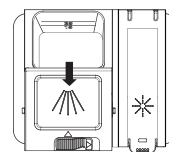
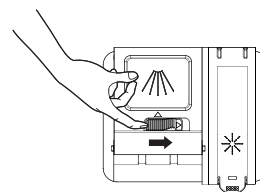

2. Add the recommended amount of detergent to the main wash detergent compartment.

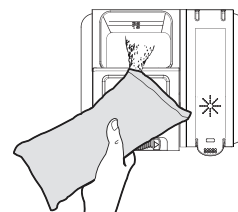

3. Close the flap and then press it down.

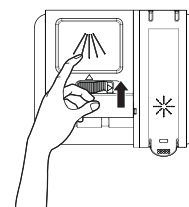

PREPARING AND LOADING DISHES

Filling the rinse aid reservoir

Your dishwasher has been designed to use liquid rinse aid only.

Using a powdered rinse aid will clog the reservoir opening and cause the dishwasher to malfunction.

Rinse aid improves the drying performance of the dishwasher.



Do not add regular detergent to the rinse aid reservoir.

1. Remove the rinse aid reservoir cap by rotating it counterclockwise.

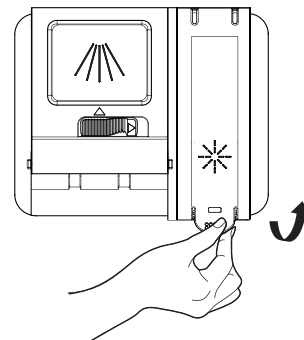

2. Fill the rinse aid reservoir with rinse aid.



Use the viewing port when filling the rinse aid reservoir.



Do not fill the reservoir above the full level indicator.

Excess rinse aid can overflow during the wash cycle.

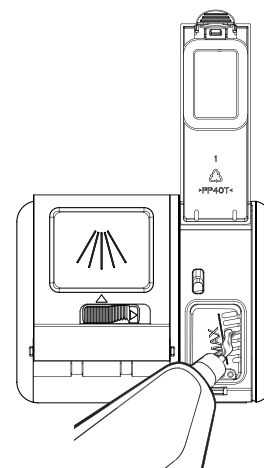

3. Close the rinse aid reservoir cap by rotating it clockwise.

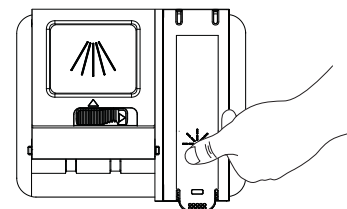

USER MAINTENANCE

Keeping your dishwasher clean improves its performance, reduces unnecessary repairs, and lengthens its life.

CLEANING THE EXTERIOR

It's best to clean spills on the outside of your dishwasher as they occur. Use a soft, damp cloth on the control panel to gently wipe away spills and dust. Do not use benzene, wax, thinner, chlorine bleach, or alcohol. These materials may discolor the inner walls and cause stains. Do not clean the dishwasher by sprinkling water over it and avoid letting water come into contact with any of the electrical parts.

 If your dishwasher has a stainless steel door panel, you can clean it with a stainless steel cleaner for Home Appliances or a similar product using a clean, soft cloth.

CLEANING THE INTERIOR

Clean the interior of your dishwasher periodically to remove any dirt or food particles. Wipe the inside of the dishwasher and the inner part of the door with a wet dishcloth. We recommend filling the detergent dispenser with dish detergent, and then running the dishwasher empty periodically using either the Normal or Express 60 cycle with the sanitize option. This will keep your dishwasher clean.

If white spots and odor are still present in your dishwasher, run the Normal cycle with the dishwasher empty and without detergent until it flushes. Then, interrupt the cycle and put an 8 ounce cup of white vinegar into the lower basket. Close the dishwasher and let the cycle finish.

 Do not remove the tub front seal (the long rubber seal enclosing the opening of the dishwasher).

 Do not touch the HEATING ELEMENT during or immediately after use.

-
1. Turn off the dishwasher.

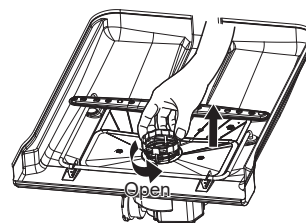

-
2. Rotate the filter insert counterclockwise to unfasten and then detach the filter insert.

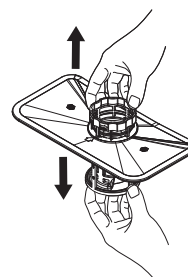

-
3. Remove the fine filter (flat, rectangular).

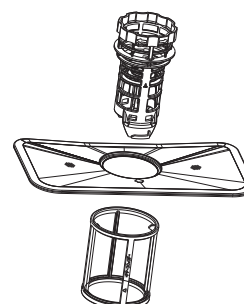

USER MAINTENANCE

4. Remove any dirt or other remains from the filters, and then rinse them under running water.

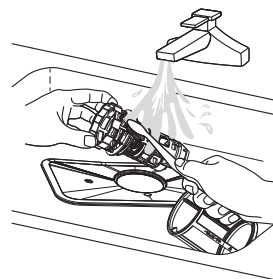

5. Reassemble the filters in the reverse order of the disassembly, replace the filter insert, and rotate clockwise to the close arrow.



CAUTION

If the filter insert is not closed properly, its performance will be decreased.

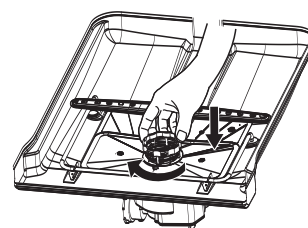

CLEANING THE NOZZLES

If your dishwasher does not seem to be cleaning adequately or the nozzles seem clogged, you can clean each of the nozzles. When removing the nozzles, take care as they may break.

Lower nozzle

1. Check whether the nozzle holes are clogged by food particles.
2. If cleaning is needed, remove the nozzle by pulling it upwards.
3. Clean the nozzle, and then push it back into place.
4. Check whether the nozzle is engaged correctly by rotating it by hand.

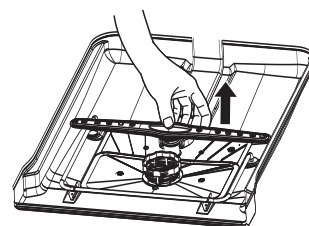

Troubleshooting

Problem	Possible cause	Solution
Dishwasher won't start	Dishwasher won't start	Shut the door completely make sure it is latched
	Power supply or power line is not connected	Check and connect the power supply
	Delay Start option has been selected	Refer to Delay Start section in this manual to reset
	Child Lock activated (selected models)	Deactivate the child lock, refer to child lock section in this manual
Dishwasher beeps at the end of the cycle	It indicates the wash cycle finished, the dishwasher will beep	
Rinse Aid light on	Rinse detergent deficient	Add rinse aid
Dishwasher operates too long	The dishwasher is connected to cold water	Check the dishwasher, make sure it is properly connected to the hot water supply
	The cycle time will vary due to the soil	When heavy soil is detected, the auto, normal, pots&pan cycle will automatically increase the cycle time
	The sanitize option is selected	When sanitize option is selected, the cycle time will be increase to meet the sanitized temperature request
Dishes are not clean enough	Water pressure is temporarily low	Use you dishwasher when the water pressure is normal
	The inlet water temperature is low	Make sure the dishwasher is connected to the hot water supply Try not use your dishwasher when hot water is being used elsewhere in the house
	Dishes are loaded too close together Improper use of detergent	Load the dishes again as the manual Add detergent depending on the water hardness and the cycle you chose. Use fresh detergent
	The selected cycle is not suitable for food soil condition	Choose anther cycle for longer washing time
	Spay arms are blocked by some items	Make sure the spay arm can rotated freely
Dishes not drying enough	Detergent dispenser is empty	Fill rinse aid dispenser or increase the amount of rinse aid.
	Improper loading of dishes	Load the dishes again as the manual instructs.
	The cycle you chose did not included the drying	Choose the proper cycle with drying
Spots and filming on dishes	Water hardness is too high	For extremely hard water install a water softener
	Improper loading of dishes	Load the dishes again as the manual indicates
	Old rinse aid is used	Use fresh rinse aid
	Rinse dispenser empty	Add rinse aid to the dispenser
Etching	Using too much detergent	Use less detergent if you have soft water
	The inlet water temperature exceeds 158°F	Lower the inlet water temperature

Troubleshooting

Problem	Possible cause	Solution
Detergent left in dispenser cup	Detergent may be too old	Use fresh detergent
	Spray arm is blocked	Load the dishes, making sure the spray arms are not blocked
Detergent dispenser will not shut	Improper operation of the detergent cover	Add the detergent and rinse aid as indicated by the manual
Water remains in the dishwasher	Previous cycle has not finished or has been interrupted	Select the proper cycle explained in the manual
Dishwasher does not drain properly	Drain is clogged	Check the air gap if you have one. Make sure the disposal is empty if the dishwasher is connected to the disposal.
	Drain hose is kinked	Make sure the drain hose is properly connected to the sink
Suds in the tub	Improper detergent is used	Make sure to use only the automatic dishwasher detergent
Dishwasher leaks	Excessive suds caused by using the improper detergent	Make sure to use only the proper dishwasher detergent
	Dishwasher is not level	Level the dishwasher
Black or gray marks on dishes	Aluminum utensils have rubbed against dishes	Rearrange the dishes Make sure the inlet water is no less than 120H
Stained tub interior	Coffee and tea soil	Using an approved spot cleaner to remove the soil
	Reddish stain	Some tomato-based foods will cause this, use of the rinse only cycle right after loading this will decrease the staining
Noises	Detergent cup opening\ Drain pump sound	This is normal
	A hard object has entered the wash module. When the object is ground up, the sound should stop	If the noise persists after a complete cycle, call for service.
Dishwasher won't fill	Water valve is turn off	Check if the water valve is turn on
	Door latch may not be properly seated	Make sure the door is closed

Error Codes

When some malfunctions come on, the appliance will display error codes to warn you:

Codes	Meanings	Possible Causes
E1	Longer inlet time.	Faucets is not opened, or water intake is restricted, or water pressure is too low.
E4	Overflow.	Some element of dishwasher leaks .
E3	Not reaching required temperature.	Malfunction of heating element.



WARNING

- If overflow occurs, turn off the main water supply before calling a service.
- If there is water in the base pan because of an overfill or small leak, the water should be removed before restarting the dishwasher.

Element Appliance Limited Warranty

(the “Products” or “Product” when referencing a singular product herein)

This Product (including any accessories included in the original packaging) as supplied and distributed in new condition, is warranted by Element Appliance Company, LLC (“Element”) to the original customer who purchases the Product from an authorized Element retailer (the “Original Customer” or “you”) against defects in material and workmanship under proper use, maintenance, and care according to the owner’s manual, warnings, and instructions accompanying the Product (“Warranty”) as follows:

* **PLEASE NOTE** – Proof of purchase evidencing the date of purchase by the Original Purchaser from an authorized Element retailer (“Valid Proof of Purchase”) is **required** for all Warranty service. The express Warranty set forth herein is subject to all terms and conditions set forth below.

1. **WARRANTY SERVICE:**

A. ONE-YEAR WARRANTY: Except as provided in subpart 1.B below, for a period of **one (1) year** from the date of purchase by the Original Customer (the “Warranty Period”), if the parts or components covered by this Warranty are determined by Element or Element’s authorized service provider to be defective in material or workmanship, Element will, at its sole and absolute discretion and option: (i) repair the defective part or component at no charge to the Original Customer, (ii) replace the defective Product with a new Product of similar or better quality, at no charge to the Original Customer, or (iii) refund the documented purchase price paid by the Original Customer (excluding tax) to the Original Customer upon return of the defective Product as directed by Element. After the Warranty Period expires, the Original Customer must pay for all parts, components, shipping and handling, labor, and replacement costs associated with the Product or any part or component thereof, regardless of any defects in the Product or any part or component thereof.

B. LIMITED EXTENDED WARRANTY THROUGH PRODUCT REGISTRATION: If and only if the Original Customer registers the Product at www.elementelectronics.com within **ninety (90)** days of the date of purchase by the Original Customer, then the Warranty Period discussed in subpart 1.A. above shall be extended an additional one (1) year to a new Warranty Period equaling **two (2) years** from the date of purchase by the Original Customer. If the Product is not registered as provided for in this subpart 1.B, then the standard one-year Warranty Period set forth in subpart 1.A shall apply.

C. TIMING AND PROCEDURE: Before Warranty service can commence, the Original Customer must contact either (i) the retailer from whom the Original Customer purchased the Product, or (ii) Element directly, in either case for problem determination and service procedures. Valid Proof of Purchase evidencing that the Product is within the Warranty Period **MUST** be presented by Original Customer in order to obtain the requested Warranty service. Please have your model and serial number available, along with your date of purchase of the Product. To remain eligible for Warranty service, Original Customer may not return the Product or any part or component thereof to the retailer or Element without Element’s prior written consent.

2. EXCLUSIONS AND LIMITATIONS TO WARRANTY SERVICE

The Warranty covers manufacturing defects in materials and workmanship of the Product encountered in the normal, non-commercial use of the Product, and **does not cover** (a) damages or malfunctions resulting from improper or unreasonable use or maintenance, abuse, negligence, failure to follow instructions contained in any written materials that accompany the Product, deterioration by reason of excess moisture, corrosive atmosphere, lightning, power surges, connections to improper voltage supply, unauthorized alteration, or other external causes such as extremes in temperature or humidity, modifications, scratches or discoloration; (b) any damage caused by using non-authorized parts or service facilities for repair of Products (however, for avoidance of doubt, using non-authorized parts or service facilities will not, in and of itself, void the Warranty); (c) transportation, shipping, delivery, pickup, insurance, installation, or set-up costs; (d) ordinary wear and tear, cosmetic damage, or damage due to acts of nature, including but not limited to, water, floods, wind, storm, tornado, earthquake, or fire, or due to damage caused by extraordinary impact events, such as dropping, crushing, demolition or other extraordinary damage; (e) commercial use of the Product, or use of the Product for anything other than single-family household or residential use; or (f) modification of the Product or any part of the Product.

This Warranty is made to the Original Customer only and does not cover Products sold AS IS or WITH ALL FAULTS. The Warranty is invalid if the factory-applied serial number has been altered or removed from the Product. This Warranty is valid only in the United States, and only applies to Product if it was purchased and serviced in the United States. The addition of equipment or features to the Product that are not manufactured or recommended by Element could affect the intended function of the Product, and therefore may void the Warranty. Furthermore, the exposure of the Product to chemicals, heat, cold, humidity, or other elements can affect the Product components, and therefore, the Warranty does not cover discoloration, fading, cosmetic changes, rust, or any damages or failure related to any such items. The Warranty is contingent upon the proper use, maintenance, and care of the Product. The Warranty may be void if the Product has been used in a manner contradictory to, or in violation of, the terms of the user's manual, warnings, or instructions accompanying the Product.

THIS WARRANTY IS MADE IN LIEU OF AND SUPERSEDES ALL OTHER WARRANTIES OR CONDITIONS OF MERCHANTABILITY OR FITNESS FOR A PARTICULAR PURPOSE OR GENERAL USE, WHETHER EXPRESS, IMPLIED, COLLATERAL, STATUTORY, OR PROVIDED BY COMMON LAW, THE UNIFORM COMMERCIAL CODE, OR OTHERWISE. ELEMENT FURTHER DISCLAIMS ALL WARRANTIES AFTER THE END OF THE WARRANTY TERM DEFINED ABOVE. NO OTHER EXPRESS WARRANTY OR GUARANTY GIVEN BY ANY OTHER PERSON, FIRM, OR ENTITY WITH RESPECT TO THE PRODUCT SHALL BE BINDING ON ELEMENT. REPAIR, REPLACEMENT, OR REFUND OF THE ORIGINAL PURCHASE PRICE, AT ELEMENT'S SOLE DISCRETION, ARE THE EXCLUSIVE REMEDIES OF THE CUSTOMER.

ELEMENT SHALL NOT BE LIABLE FOR ANY INCIDENTAL OR CONSEQUENTIAL DAMAGES CAUSED BY THE USE, MISUSE, OR INABILITY TO USE THE PRODUCT. THESE INCLUDE, BUT ARE NOT LIMITED TO, ANY DAMAGES IN THE FORM OF LOST PROFITS, LOSS OF USE, LEGAL FEES, ECONOMIC LOSS, PERSONAL INJURIES, OR ANY OTHER DAMAGES CAUSED BY CIRCUMSTANCES BEYOND THE CONTROL OF ELEMENT. NOTWITHSTANDING THE FOREGOING, ELEMENT'S AGGREGATE LIABILITY TO ANY CUSTOMER SHALL NOT EXCEED THE ORIGINAL PURCHASE PRICE OF THE PRODUCT. THIS WARRANTY SHALL NOT EXTEND TO ANYONE OTHER THAN THE ORIGINAL CUSTOMER WHO PURCHASED THE PRODUCT, AND IS NOT

TRANSFERRABLE. NO PERSON IS AUTHORIZED TO ALTER, EXTEND, OR WAIVE THIS WARRANTY OR ANY OF ITS TERMS OR CONDITIONS.

Some states do not allow the exclusion or limitation of incidental or consequential damages, or allow limitations on warranties, so the above limitations or exclusions may not apply to you. This Warranty gives you specific rights, and you may have other rights, which vary from state to state. The exclusions and limitations to the Warranty apply to the maximum extent permitted by law and unless restricted or prohibited by law. Where any term of this Warranty is prohibited by applicable law, it shall be null and void, but the remainder of this Warranty shall remain in effect.

PLEASE DIRECT ALL CORRESPONDENCE TO:

Element Appliance Company, LLC
customerservice@elementelectronics.com
(888) 842-3577
<https://elementelectronics.com>

Element, the Element Logo, and Bring it home are trademarks of Element Brand Holding, LLC. All other trademarks are the property of their respective owner, who has not sponsored, endorsed, or approved this product. ©2024 Element Appliance Company, LLC. All rights reserved.

Distributed by Element Appliance Company, LLC Augusta, GA 30909

For service, support and warranty information:
Call 888.842.3577, email us at customerservice@elementelectronics.com or visit
www.elementelectronics.com